



# MILITARY APPLICATIONS

 **Unibridge**<sup>®</sup>  
by Matiere<sup>®</sup>



## THE MATIÈRE® COMPANY

### HISTORY

In 1932, Louis Matière installed his first water conduits. Since that era, the Matière® Company has laid approximately 45,000 kilometres of pipes.

Today, Matière® is specialised in four activities throughout the world: metallic structures (60%), concrete structures (30%) excavation, watersupply and sanitation (10%).

### STEEL BRIDGES

- Permanent girder and box girder bridges
- Footbridges
- Flyovers
- Ro-Ro Jetty
- UNIBRIDGE® prefabricated and pre-designed modular system

### PREFABRICATED CONCRETE STRUCTURES

Modular pre-cast concrete arches for:

- Underpasses
- Road and rail tunnels
- Service ducts

### EXPORT

Present in many countries, where it has built 12,000 exemplary structures, Matière® earns 75% of its revenue internationally.

Twenty countries are trustees of the concrete patents and technical know-how, manufacturing products under licence for Matière®.

### COMPANY STRUCTURE

**3 production sites in France:**  
Aurillac, Bagnac sur Célé and Avignon.

**Administrative headquarters** (design offices and logistics) with 250 permanent employees.

**3 sales offices in France:**  
Aurillac, Paris and Lyon.

**Other permanent establishments and overseas offices:**  
The Philippines, Algeria, Cameroon and Australia.



## UNIBRIDGE® CONCEPT

### BASIC PRINCIPLE

Made of pre-designed prefabricated steel box girders either 11.40 metres or 6 metres long, assembled lengthwise by pins and transversally by spacers, the UNIBRIDGE® is entirely modular.

It is possible to construct bridges with multiple spans. At this time, the maximum length between two abutments is limited to 50 metres.

UNIBRIDGE® structures are supplied with the whole range of components needed for assembly, and come with an assembly manual specifying the identification, marking and weight of each part.

### SPECIFICS

- A modular steel bridge system, for permanent use, which may be quickly dismantled and reassembled
- Roadway can be either steel with anti-skid system or concrete deck
- Single or multiple traffic lanes
- Simple and clean design assembled with minimum number of components

### AN INTERNATIONAL PRODUCT

Structures installed across 5 continents demonstrate the versatility and flexibility of this product.

Over 500 UNIBRIDGE® bridges have been built or ordered in France, Australia, The Philippines, Papua New Guinea, Iraq, Haiti and many African countries.





Central African Republic

## A HIGHLY REDUCED NUMBER OF INDUSTRIAL COMPONENTS

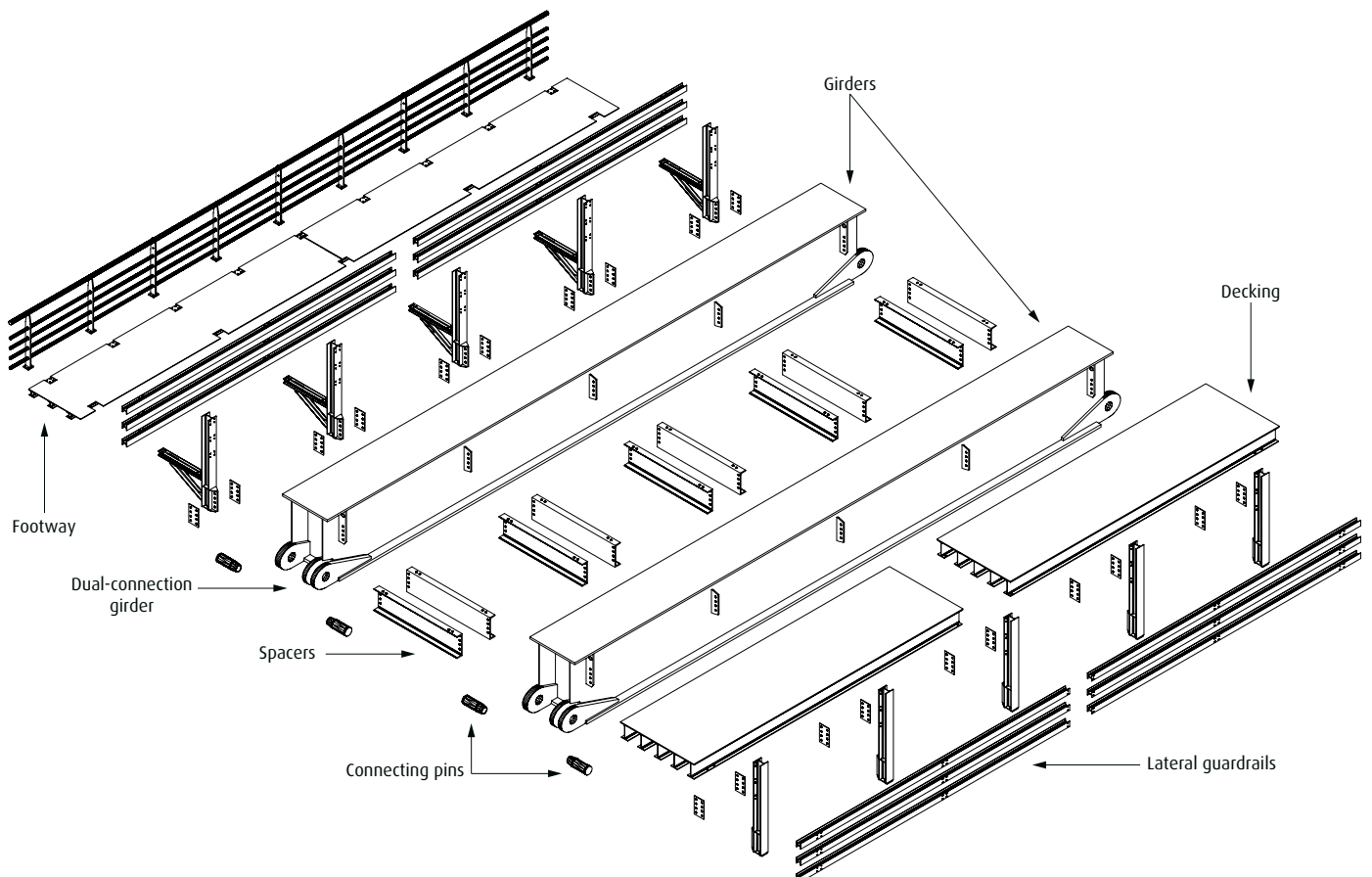



# TOTAL MODULARITY IN LENGTH AND WIDTH

6-metre box girder

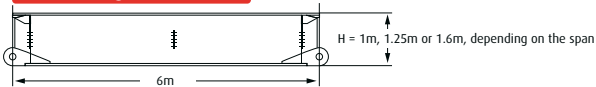

11.40-metre box girder

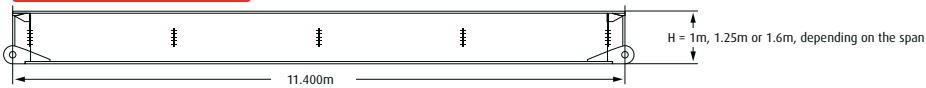

Bridge beams made from UNIBRIDGE® box girders, assembled lengthwise

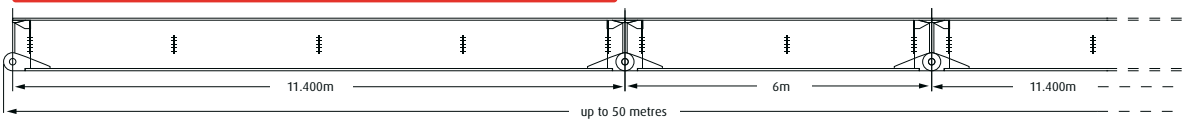

Single-lane bridge with footway

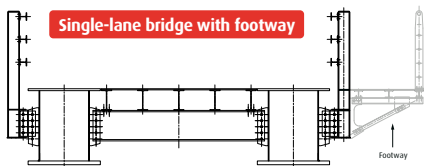

Dual-lane bridge with footway

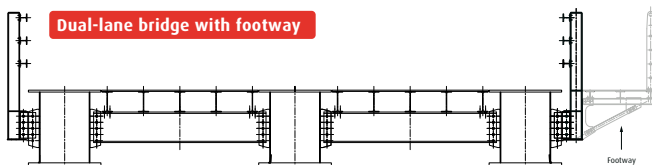

Triple-lane bridge with footway

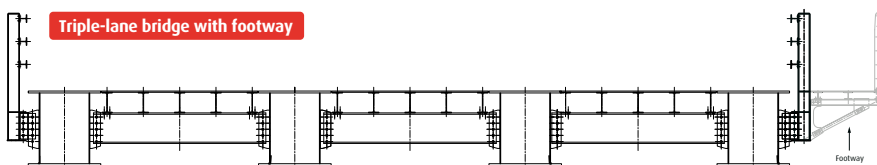



*New Caledonia*



*Reunion Island*



*Philippines*



*Central African Republic*



*Cameroon*



*Central African Republic*

## UNIBRIDGE®: THE POST-CONFLICT MILITARY BRIDGE

### QUALITY

- Modern production techniques using high grade steels.
- UNIBRIDGE® has been pre-designed against applicable loads within the country where they are installed - AASHTO, Eurocodes, British Standards, Australian Standards, etc.
- A high quality control process is run throughout the entire manufacturing cycle and guarantee the traceability of all structural components.
- Corrosion protection: Main components are painted in compliance with ACQPA specifications and other components are galvanised.

### LOGISTICS

- **Storage:** a reduced number of components simplifies storage management.
- **Transportation:** by road, a semi-trailer lorry is sufficient; by sea all components fit into 40-foot containers.
- **Erection and Dismantling:** no specific technical skill is required. Bridges are built by launching or crane lift-in.
- **Use:** UNIBRIDGE® is suitable for a wide range of military and civilian vehicles and eliminates the possibility of vehicular collision with the structural trusses.



*Haiti*



*Reconstruction of Al-Nahrawan bridge in Iraq, March 2010  
Length: 140 ml - Load classification: MC 100  
Construction time for superstructure: 3 weeks*

## **FLEXIBILITY**

- UNIBRIDGE® can be used as a temporary bridge in an emergency or crisis situation.
- UNIBRIDGE® can be used as a permanent bridge (100 year life span) and has been designed for 1,000,000 fatigue cycles.
- Transversal modularity allows a bridge of any width with either steel or concrete deck.
- Fast production processes, quick delivery to site and rapid erection.

## **VARIOUS USES**

- Emergency bridge
- Home land disaster relief
- Create permanent replacement for in-service military bridges on civilian traffic routes
- CIMIC operations
- Humanitarian operations

## **3 POSSIBLES CONTRACTS**

- Delivery and rapid assembly on site
- Delivery and technical assistance on site
- Delivery only





1, Place d'Iéna  
75116 PARIS FRANCE

2, rue Louis Matière  
BP 54 - 15130 ARPAJON/CÈRE FRANCE

Tél. : +33 (0) 4 71 46 50 00

Fax : +33 (0) 4 71 64 63 90

www.matiere.fr